

# TRIEXTA

Trieur / GUTR

Genç Değirmen<sup>®</sup>  
MILLING MACHINERY

*Excellent Milling Properties...*

## WORKING PRINCIPLES

Trieur is used to separate broken, round and long grains and mixed unwanted grains like barley, rye, oat in wheat by their forms and sizes. That rotating drums which has cylindrical form, has selectors inner surfaces and thanks to this selectors, unwanted substances separates from other grains and sent to trough into the drums and they transports to outside by spirals. Un separated grains, goes to exit way and the separating operation has be done. Trieur's selector sheets has variable sizes for use different purposes.



## Product Data Sheet

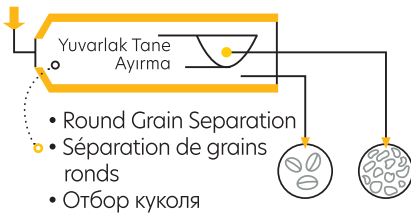

- Round Grain Separation
- Séparation de grains ronds
- Отбор куколя

Type	Technical Features				Motor (kw)
	Wheat/rye	Barley/White Rice	Oats/Paddy Rice	Diameter / length w(mm)	
GUTR 401/7	8.0	7.5	5.5	700/2500	2.2
GUTR 401/8	10.0	10	7.5	700/3000	2.2

Type	Technical Features				Motor (kw)
	Wheat/rye	Barley/White Rice	Oats/Paddy Rice	Diameter / length w(mm)	
GUTR 401/17 <sup>n</sup>	7.0	5.5	4.0	700/2500	2.2
GUTR 401/18 <sup>n</sup>	8.5	7.5	5.1	700/3000	2.2

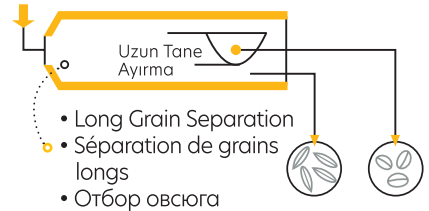

- Long Grain Separation
- Séparation de grains longs
- Отбор овсяга

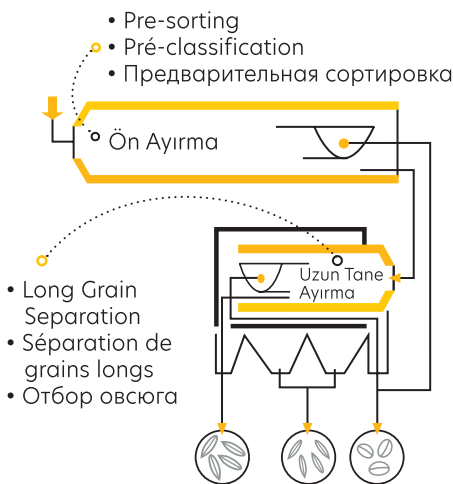

- Pre-sorting
- Pré-classification
- Предварительная сортировка
- Long Grain Separation
- Séparation de grains longs
- Отбор овсяга

Type	Technical Features			Motor (kw)	
	Wheat/rye	Diameter / length w(mm)	Diameter / length w(mm)	Main Separation	Resorting
GUTR 403/6 <sup>n</sup>	9.0-10.0	700/2500	600/1500	2.2	1.1
GUTR 403/7 <sup>n</sup>	11.0-13.0	700/3000	600/1500	2.2	1.1

Type	Technical Features			Motor (kw)	
	Wheat/rye	Barley	Diameter / length w(mm)	Round Grain Separation	Long Grain Separation
GUTR 404/6	6.0	5	700/2500	2.2	2.2
GUTR 404/7	8.5	7.5	700/3000	2.2	2.2

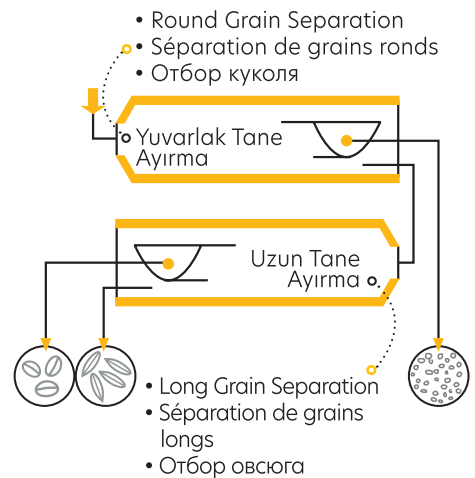

- Round Grain Separation
- Séparation de grains ronds
- Отбор куколя

- Long Grain Separation
- Séparation de grains longs
- Отбор овсяга

- Long Grain Separation
- Séparation de grains longs
- Отбор овсяга

- Round Grain Separation
- Séparation de grains ronds
- Отбор куколя

Type	Technical Features				Motor (kw)		
	Wheat/rye	Diameter / length w(mm)		Separation Round/Long	Re-Sorting Round/Long		
GUTR 407/6	9.0-10.0	700/2500	600/1500	2.2	2.2	1.1	
GUTR 407/7	11.0-13.0	700/3000	700/3000	2.2	2.2	1.1	

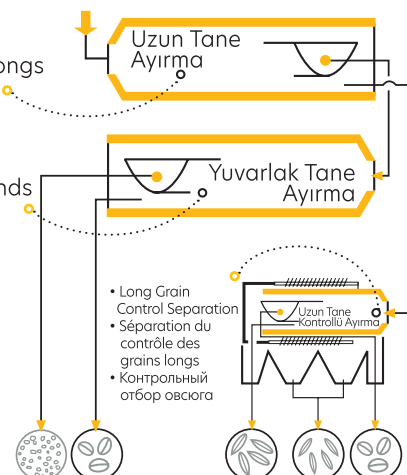

- Long Grain Control Separation
- Séparation du contrôle des grains longs
- Контрольный отбор овсяга

## Product Data Sheet

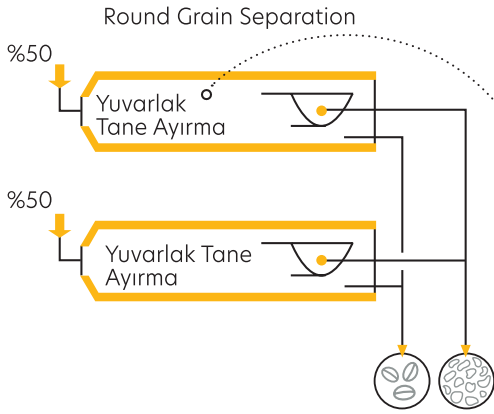

- Round Grain Separation
- Séparation de grains ronds
- Отбор куколя

Type	Technical Features		Motor (kw)
	Wheat/rye	Diameter / length w(mm)	Seperation Round/ Long
GUTR 410/2	16.0	700/2500	2x2.2
GUTR 410/3	20.0	700/3000	2x2.2

Type	Technical Features			Motor (kw)
	Wheat/rye	Barley	Diameter / length w(mm)	
GUTR 412/1	30.0	30.8	3x700/3000	3 x 2.2

- Round Grain Separation
- Séparation de grains ronds
- Отбор куколя

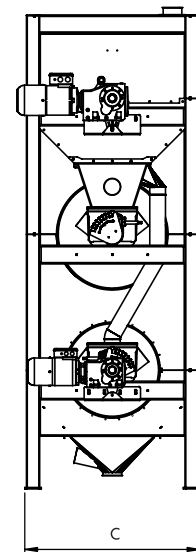
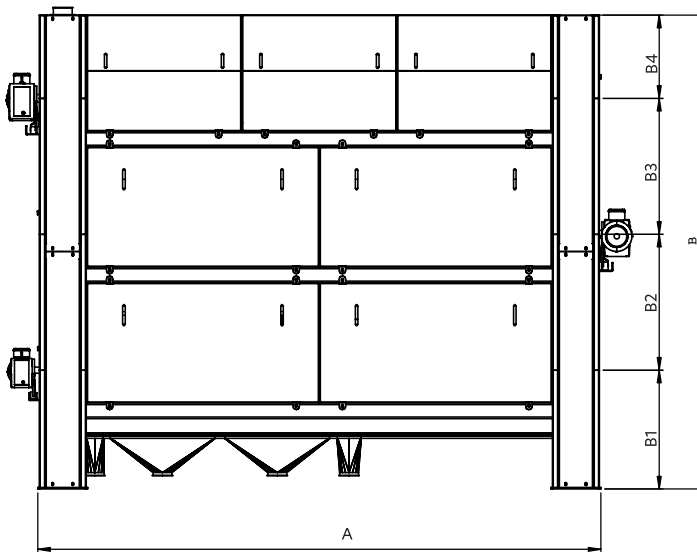
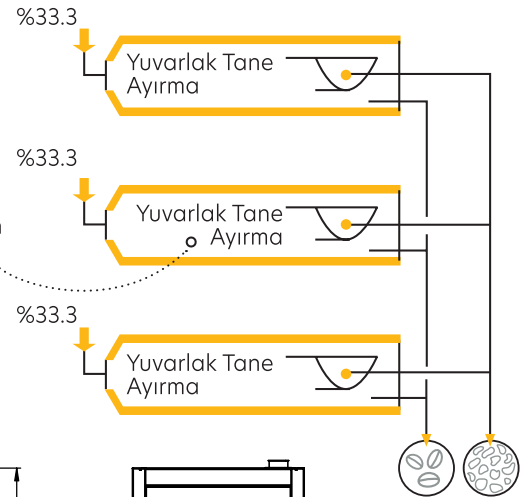

Type	Technical Features						Weight
	A	B				C	
		B1	B2	B3	B4		
GUTR 401/7	2605	760	-	-	530	965	1800
GUTR 401/8	3105	760	-	-	530		1850
GUTR 401/17	2605	760	-	-	530		2100
GUTR 401/18	3105	760	-	-	530		2450
GUTR 403/6	2605	760	870	-	530	1110	2650
GUTR 403/7	3105	760	870	-	530		1750
GUTR 404/6	2605	870	870	-	530		1900
GUTR 404/7	3105	870	870	-	530	965	2400
GUTR 407/6	2605	760	870	870	530		2500
GUTR 407/7	3105	760	870	870	530	1110	1750
GUTR 410/2	2605	870	870	-	530		1900
GUTR 410/3	3105	870	870	-	530		2700
GUTR 412/1	3105	870	870	870	530		